

PROJECT \_\_\_\_\_  
 TYPE \_\_\_\_\_  
 SPECIFIER \_\_\_\_\_  
 QUANTITY \_\_\_\_\_  
 DATE \_\_\_\_\_

## CRASH SURFACE

**D132044-** \_\_\_\_\_  
 base number

- To build a product code in our configurator select the specify button on the base model # product page
- To build a manual product code on this datasheet choose from the options listed below in blue font and add the suffix to the base model #

### GENERAL

Series: Crash  
 Brand: Knikerboker  
 Division: Design  
 Mounting Type: Surface  
 Mounting Location: Ceiling  
 Subcategory: Ambient

### PHYSICAL

Shape: Abstract  
 Length (mm): 1000  
 Length (in): 39 <sup>3</sup>/<sub>8</sub>  
 Width (mm): 400  
 Width (in): 15 <sup>3</sup>/<sub>4</sub>  
 Height (mm): 240  
 Height (in): 9 <sup>7</sup>/<sub>16</sub>  
 Extension (mm): 250  
 Extension (in): 9 <sup>13</sup>/<sub>16</sub>  
 Light Distribution: Indirect  
 Fixture Finish: EWH / EBK / MAN / COF / PRD / SLF / GLF / CLF / BRL / EWS / EWG / EWC / EWR / EBS / EBG / EBC / EBC / EBB / MAS / MAD / MAC / MAB / COS / CGO / CCL / CBL / PRS / PRG / PRC / PRB  
 Fixture Material: Metal

### ELECTRICAL

Lamp Type: LED  
 Input Wattage (W): 10.5  
 Total Output Wattage (W): 10  
 Dimming: Tri-Mode (Non-Dimming and Phase Dimming (120Vac only) and 0-10V Dimming)  
 Driver Included: Yes  
 Driver Location: Integrated  
 Driver Type: Constant Current - Universal  
 Driver Class: Class 2  
 Input Voltage (V): 120 - 277  
 Constant Current (MA): 250  
 Upon Request: 0-10Vdc dimming / Phase dimming @120Vac / 277Vac

### LED

Number of LEDs: 1  
 Color Temperature (°K): 3000  
 Max. Delivered Lumen (lm): 2200  
 CRI: >85 CRI  
 Lamp Life (hrs): 50000

### OPTICAL

### RATINGS AND CERTIFICATIONS

Certified By: Certified for North American Standards  
 IP rating: IP20

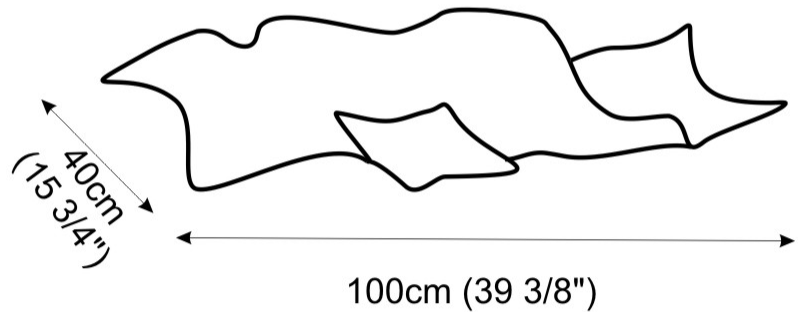

## CRASH SURFACE

**D132047-** \_\_\_\_\_

base number

1. To build a product code in our configurator select the specify button on the base model # product page
2. To build a manual product code on this datasheet choose from the options listed below in blue font and add the suffix to the base model #

### GENERAL

Series: Crash  
Brand: Knikerboker  
Division: Design  
Mounting Type: Surface  
Mounting Location: Ceiling

### PHYSICAL

Shape: Rectangle  
Length (mm): 300  
Length (in): 11 <sup>13</sup>/<sub>16</sub>  
Width (mm): 300  
Width (in): 11 <sup>13</sup>/<sub>16</sub>  
Light Distribution: Indirect  
Fixture Finish: EWH / EBK / MAN / COF / PRD / SLF / GLF / CLF / BRL / EWS / EWG / EWC / EWR / EBS / EBG / EBC / EBC / EBB / MAS / MAD / MAC / MAB / COS / CGO / CCL / CBL / PRS / PRG / PRC / PRB  
Fixture Material: Metal

### ELECTRICAL

Lamp Type: LED  
Input Wattage (W): 10.5  
Total Output Wattage (W): 10  
Dimming: Tri-Mode (Non-Dimming and Phase Dimming (120Vac only) and 0-10V Dimming)  
Driver Included: Yes  
Driver Location: Integrated  
Driver Type: Constant Current - Universal  
Driver Class: Class 2  
Input Voltage (V): 120 - 277  
Constant Current (MA): 250  
Upon Request: 0-10Vdc dimming / Phase dimming @120Vac only / 277Vac

### LED

Number of LEDs: 1  
Color Temperature (°K): 3000  
Max. Delivered Lumen (lm): 1100  
CRI: >85 CRI  
Lamp Life (hrs): 50000

### OPTICAL

#### RATINGS AND CERTIFICATIONS

Certified By: Certified for North American Standards  
IP rating: IP20

|           |       |
|-----------|-------|
| PROJECT   | _____ |
| TYPE      | _____ |
| SPECIFIER | _____ |
| QUANTITY  | _____ |
| DATE      | _____ |

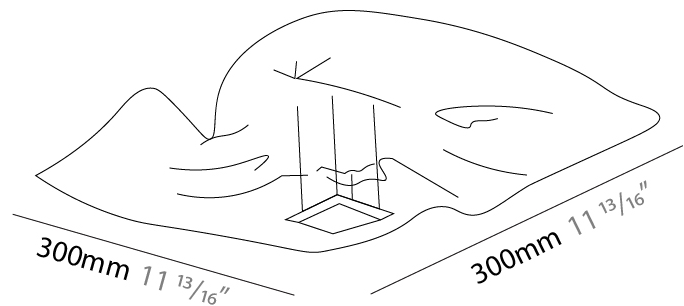

## CRASH SURFACE

D132047-

PROJECT

TYPE

SPECIFIER

QUANTITY

DATE



|           |
|-----------|
| PROJECT   |
| TYPE      |
| SPECIFIER |
| QUANTITY  |
| DATE      |

## CRASH SURFACE

**D132109-** \_\_\_\_\_  
base number

- To build a product code in our configurator select the specify button on the base model # product page
- To build a manual product code on this datasheet choose from the options listed below in blue font and add the suffix to the base model #

### GENERAL

Series: Crash  
 Brand: Knikerboker  
 Division: Design  
 Mounting Type: Surface  
 Mounting Location: Ceiling  
 Subcategory: Pendant

### PHYSICAL

Shape: Abstract  
 Length (mm): 200  
 Length (in): 7 7/8  
 Width (mm): 200  
 Width (in): 7 7/8  
 Height (mm): 250  
 Height (in): 9 13/16  
 Light Distribution: Indirect  
 Fixture Finish: EWH / EBK / MAN / COF / PRD / SLF / GLF / CLF / BRL / EWS / EWG / EWC / EWR / EBS / EBG / EBC / EBB / MAS / MAD / MAC / MAB / COS / CGO / CCL / CBL / PRS / PRG / PRC / PRB  
 Fixture Material: Metal

### ELECTRICAL

Lamp Type: LED  
 Input Wattage (W): 10.5  
 Total Output Wattage (W): 10  
 Dimming: Tri-Mode (Non-Dimming and Phase Dimming (120Vac only) and 0-10V Dimming)  
 Driver Included: Yes  
 Driver Location: Integrated  
 Driver Type: Constant Current - Universal  
 Driver Class: Class 2  
 Input Voltage (V): 120 - 277  
 Constant Current (MA): 250  
 Upon Request: 0-10Vdc Dimming / Phase dimming @120Vac only / Non-dimming 120/277Vac

### LED

Number of LEDs: 1  
 Color Temperature (°K): 3000  
 Max. Delivered Lumen (lm): 1100  
 CRI: >85 CRI  
 Lamp Life (hrs): 50000

### OPTICAL

### RATINGS AND CERTIFICATIONS

Certified By: Certified for North American Standards  
 IP rating: IP20

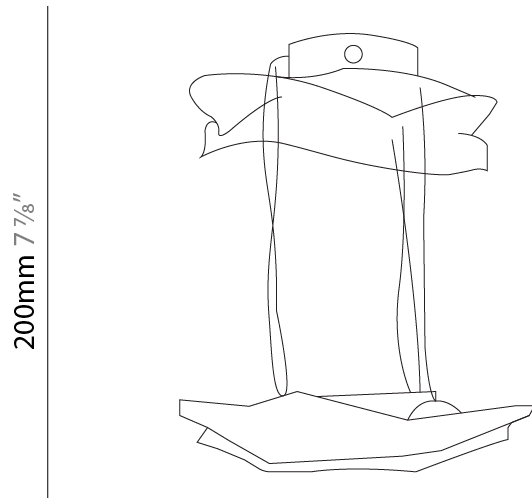
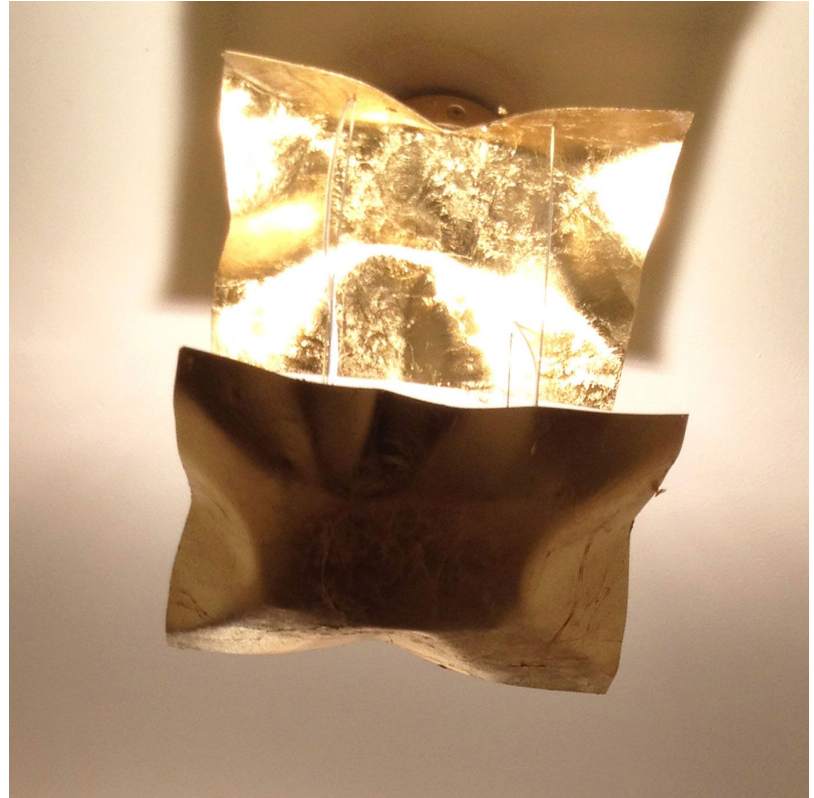

200mm 7 7/8"

200mm 7 7/8"



## CRASH SURFACE

D132109-

|           |       |
|-----------|-------|
| PROJECT   | _____ |
| TYPE      | _____ |
| SPECIFIER | _____ |
| QUANTITY  | _____ |
| DATE      | _____ |

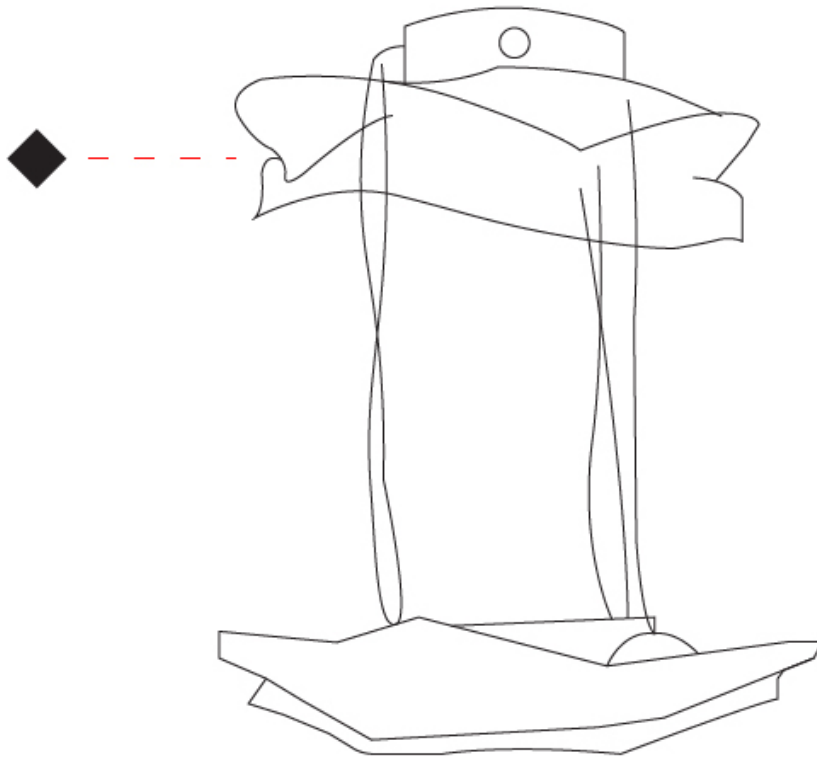

D

## CRASH

### COLOR FINISH CHART

#### Fixture Finish

Embossed White - EWH



Embossed Black - EBK

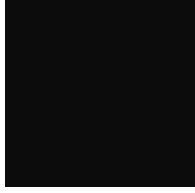

Metallic Anthracite - MAN

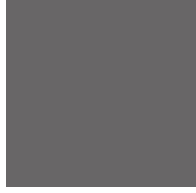

Coffee - COF

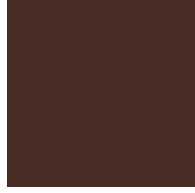

Purple Red - PRD



Silver Leaf - SLF

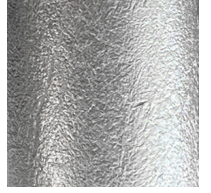

Gold Leaf - GLF

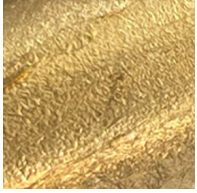

Copper Leaf - CLF



Bronze Leaf - BRL



Metallic Anthracite / Silver Leaf - MAS

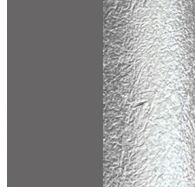

Metallic Anthracite / Gold Leaf - MAD

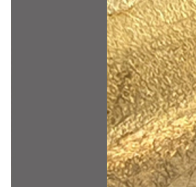

Metallic Anthracite / Copper Leaf - MAC

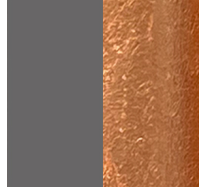

Metallic Anthracite / Bronze Leaf - MAB



Coffee / Silver Leaf - COS

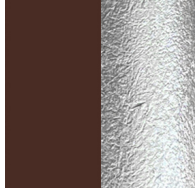

Coffee / Gold Leaf - CGO

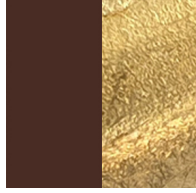

Coffee / Copper Leaf - CCL



Coffee / Bronze Leaf - CBL



Purple Red / Silver Leaf - PRS

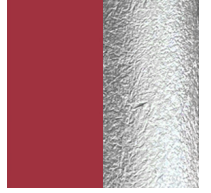

Purple Red / Gold Leaf - PRG

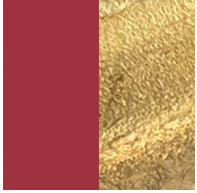

Purple Red / Copper Leaf - PRC



Purple Red / Bronze Leaf - PRB







































































**Digital:** Not all screens are calibrated the same, and therefore, colors will appear differently between screens.

**Physical:** When texture is involved, there will be variations in color, character and tone within a product series and between product families.













|           |  |
|-----------|--|
| PROJECT   |  |
| TYPE      |  |
| SPECIFIER |  |
| QUANTITY  |  |
| DATE      |  |











### LEGEND

|                                                                                                                                              |                                                                                                                                                |                                                                                                                                                                                    |
|----------------------------------------------------------------------------------------------------------------------------------------------|------------------------------------------------------------------------------------------------------------------------------------------------|------------------------------------------------------------------------------------------------------------------------------------------------------------------------------------|
|  floor-mounted                                               |  pivotable                                                    |  special LED (upon request) RGB, RGBW, tunable, gold+, meat+, art+, fashion+                    |
|  wall and ceiling: recessed and surface mounted              |  rotating                                                     |  warm dim / natural dimming LED                                                                 |
|  ceiling-mounted and wall-mounted                            |  illuminate tilted                                            |  rechargeable battery powered                                                                   |
|  wall-mounted                                                |  color of suspension cable                                    |  fixture with natural vivid LED (upon request)                                                  |
|  omni-directional light distribution                         |  length of suspension cable                                   |  color rendering index                                                                          |
|  direct light distribution                                   |  reflector degree selection                                   |  color temperature                                                                              |
|  direct/indirect light distribution                          |  super spot                                                   |  lumen (luminous flux)                                                                          |
|  indirect light distribution                                 |  lens                                                         |  efficacy (lumens per watt)                                                                     |
|  asymmetric light distribution                               |  lens pack                                                    |  Unified Glare Rating (UGR) range from 5-40                                                     |
|  aura light distribution                                     |  shine ring                                                   |  marine grade (AISI 316 stainless steel)                                                        |
|  round wall or ceiling cut-out                               |  integrated shine ring with diffuser                          |  walk on                                                                                        |
|  square wall or ceiling cut-out                              |  free individual colors 01-29                                 |  drive on                                                                                       |
|  the supplied jig specifies the cutout dimensions            |  individual colors: 00 (free of charge), 01-25 (extra charge) |  Dark Sky Compliance                                                                            |
|  minimum distance (meters) lamp - object                     |  luminaire part to be colored (F1)                            |  Americans with Disabilities Act (less than 4" off the wall located between 27"-84" from floor) |
|  recessed depth                                              |  luminaire part to be colored (F2)                            |  lamp protected against explosion                                                               |
|  ceiling thickness in mm                                    |  luminaire part to be colored (F3)                           |  blown glass using traditional methods by master glass blower                                  |
|  ceiling thickness selection                               |  luminaire part to be colored (F4)                          |  acoustic material                                                                            |
|  dimmable DP (phase), DV (0-10V), DD (dali), DS (step-dim) |  luminaire part to be colored (F5)                          |  protection class I, protection insulation                                                    |
|  included or excluded LED driver/transformer/control gear  |  color of 3-circuit adaptor                                 |  protection class II, protection insulation                                                   |
|  separately switchable                                     |  indirect diffuser                                          |  ETL Certified to UL and CSA Standards                                                        |
|  sensor                                                    |  direct diffuser                                            |  UL Certified to UL and CSA Standards                                                         |
|  remote control                                            |  ball-proof (upon request)                                  |  CSA Certified to UL and CSA Standards                                                        |
|  available upon request                                    |  accessory                                                  |  Certified for North American Standards                                                       |

### IP RATING

|                                                                                        |                                                                                                                                                  |
|----------------------------------------------------------------------------------------|--------------------------------------------------------------------------------------------------------------------------------------------------|
|  IP20 | protected against ingress of solid bodies greater than 12.5mm (finger)                                                                           |
|  IP33 | protected against ingress of solid bodies greater than 2.5mm<br>protected against sprays of water up to 60 degrees from the vertical (rain)      |
|  IP40 | protected against ingress of solid bodies greater than 1mm (wire)<br>no protection against the ingress of moisture                               |
|  IP43 | protected against ingress of solid bodies greater than 1mm (wire)<br>protected against sprays of water up to 60 degrees from the vertical (rain) |
|  IP44 | protected against ingress of solid bodies greater than 1mm (wire)<br>protected against water splashed from all directions                        |
|  IP54 | protected against limited ingress of dust (wet rooms/covered outdoor areas)<br>protected against water splashed from all directions              |
|  IP65 | protected against ingress of dust<br>protected against jets of water                                                                             |
|  IP66 | protected against ingress of dust<br>protected against powerful jets of water or heavy seas                                                      |
|  IP67 | protected against ingress of dust<br>protected against immersion of water between 15cm - 1m for 30 minutes                                       |
|  IP68 | protected against ingress of dust<br>protected against immersion of water under pressure for long periods                                        |

### IK RATING

|                                                                                          |                                                                                                       |
|------------------------------------------------------------------------------------------|-------------------------------------------------------------------------------------------------------|
|  IK01 | protected against 0.14 joules impact (equivalent to 0.25kg mass dropped from 56mm above the surface)  |
|  IK02 | protected against 0.2 joules impact (equivalent to 0.25kg mass dropped from 80mm above the surface)   |
|  IK03 | protected against 0.35 joules impact (equivalent to 0.25kg mass dropped from 140mm above the surface) |
|  IK04 | protected against 0.5 joules impact (equivalent to 0.25kg mass dropped from 200mm above the surface)  |
|  IK05 | protected against 0.7 joules impact (equivalent to 0.25kg mass dropped from 280mm above the surface)  |
|  IK06 | protected against 1 joules impact (equivalent to 0.25kg mass dropped from 400mm above the surface)    |
|  IK07 | protected against 2 joules impact (equivalent to 0.5kg mass dropped from 400mm above the surface)     |
|  IK08 | protected against 5 joules impact (equivalent to 1.7kg mass dropped from 300mm above the surface)     |
|  IK09 | protected against 10 joules impact (equivalent to 5.0kg mass dropped from 200mm above the surface)    |
|  IK10 | protected against 20 joules impact (equivalent to 5.0kg mass dropped from 400mm above the surface)    |